

Article number: 201242425

Description: E+G Retaining magnets with threaded stud GN 52.4-ND-25-M6-E
Neodymium, iron, boron - 80° C, 190N

Measures

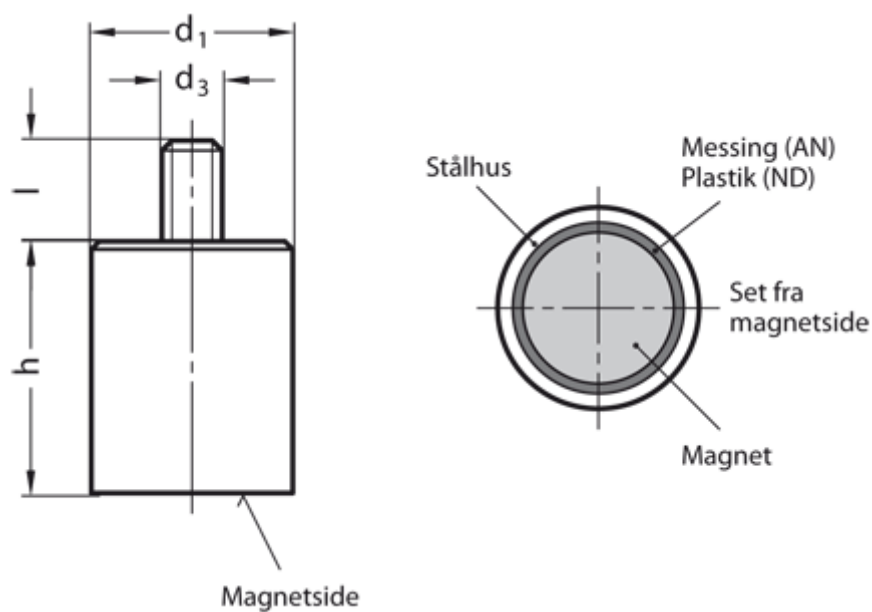

d1	= 25
d3	= M6
h	= 35 ±0,2
Holding force N	= 190.0
l	= 10
Material	= ND Neodym, iron, boron, 80°C